

Synthesis of a Self-Reeling Hose System for Bathroom Use

Hui Lin See¹, Zairulazha Zainal^{1*}, Shamsul Anuar Shamsudin¹ and Huthaifa Ahmad Al_Issa²

¹Fakulti Kejuruteraan Mekanikal, Universiti Teknikal Malaysia Melaka,
75450 Ayer Keroh, Melaka

²Electrical and Electronics Engineering Department, Al Balqa Applied University, Jordan

ABSTRACT

This work was carried out to design and test the self-reeling hose for bathroom use to achieve convenience and hygiene in the bathroom. The distribution of von Mises stress, displacement and safety factors were considered. SolidWorks, which is a solid modeling computer-aided design and engineering (CAD/CAE) software was used to integrate analysis and to help simulate physical interactions in engineering design such as stress, deflection and safety factors to match various parts of the self-reeling hose mechanisms. The House of Quality (HOQ) table was constructed to determine the engineering characteristics of the product. Three different design concepts were synthesized from the morphological chart and a design concept that was most critical to fulfilling the criteria was chosen using the method of Pugh concept selection. Consequently, the computer analysis and simulation for particular parts were done and the finalized assembly were presented. The bending force and torque of the ratchet and pawl system were calculated to ensure safety in its operation. Overall, the mechanism is safe to manufacture and use with the appropriate materials and design considerations.

Keywords: Self-reeling, hose, machine design, analysis

1. INTRODUCTION

In many societies, cleaning oneself with water after using the toilet is the practice instead of using toilet rolls. This is especially common in Muslim and Asian communities around the world. These days, plastic hoses and dedicated bidets are usually the accessories in bathrooms and restrooms to fulfill this task. However, oftentimes, the hoses are left on the wet floors in the bathrooms or toilet stalls. Unfortunately, this makes the hoses and bidets rather unhygienic to use.

Hence, a self-reeling hose is an invention that allows the hose to be pulled out and then lock the reeling mechanism to prevent the hose from retracting. When finish using, the hose can be automatically reeled back into its housing [1]. Such a system also prevents the formation of kinks and knots in the hose and keeps the hose tidy in the bathroom by not touching the wet and relatively dirty floor. There are various types of power source that can actuate the mechanism for the self-reeling hose, which include spring powered, water powered and battery powered. The solution that is most widely used is the spring powered hose retracting mechanism. This is because the spring powered system uses the starter rewind spring which is more durable and stronger as compared to water powered or battery powered hose retracting mechanism [2]. This is especially true if the hose is not too long.

The advantage of such a system is particularly the cleanliness of the hose. As mentioned earlier, a bathroom hose can be lying on the floor in the bathroom. This is unhygienic since the main purpose of the hose is to direct water to clean the dirty part of the body after relieving oneself in the toilet. The hose itself must first be clean. Hence, it must be stored neatly after use.

*zairulazha@utem.edu.my

Therefore, the approach of this work includes the following. First, to design the components of the self-reeling hose for bathroom use. Second, to implement the mechanism of spring and ratchet. Third, to test the simulation of mechanism in SolidWorks software. Many components have to be designed or selected to suit the objectives of this work. Nowadays, many one-off parts can be produced fairly quickly using the additive manufacturing (AM) technologies. Chand, Sharma and Trehan [3] found that using a multi-jet printing machine, the best mechanical properties for the components can be achieved when the maximum area is touching the base plate of the printer. Load bearing parts must not be printed at an inclined plane either. Furthermore, one of the most important part is the spring. There are many spring types available to choose from. However, making them using AM would possibly be the best in achieving the desired spring properties. Arshad, Nazir and Jeng [4] used the HP MJF 520 machine to produce springs with a variety of variable settings and found that a higher helix number increases the spring stiffness. Conversely, it would also decrease the fatigue life exponentially. Another related study worked with variable-dimension helical springs for cushioning impacts in shoes using an AM technology [5]. Even non-helical springs can be fabricated with AM technology using Shape-Memory Polymers (SMP) and flexible elastomer as tested by Yuan *et al.* [6]. On the other hand, discussions on a more conventional spring material selection was given by Das and Kumar, advocating the use of ASTM A 401 and 228 steels [7].

Another interesting component in such a system being developed is gear. This standard part can be purchased ready-made from the market. However, it can also be 3D-printed to achieve certain dynamic performance by controlling the printing parameters as investigated by Zhang *et al.* [8]. Moreover, Pisula *et al.* [9] studied the wear in non-metal gears produced with AM technology and concluded that PEEK material was the most wear resistant, while Ultem 9085 performed the worst. In the end, these are interesting choices to consider when physical prototypes or models are to be made.

2. MATERIAL AND METHODS

There are various parameters used in this synthesis such as stress distribution, size dimensions, safety factors, and materials, just to name a few. Consequently, the Quality Function Deployment (QFD) is used, where it is a planning and team problem-solving tool that has been adopted by many organizations. Through the product development process, QFD becomes the tool of choice for focusing a design team's attention on satisfying customer needs [9].

In this work, a House of Quality (HOQ) table was created. An HOQ is a product planning tool of the QFD, where it develops the relationship between customer needs and the product features that are most critical to fulfilling customer requirements. It can also determine the engineering characteristics of the design for selecting the best design to manufacture [10]. The completed HOQ table for the retractable hose is shown in Table 1.

The morphological chart in Table 2 is a method to generate ideas based on function analysis. The various functions of the product can be established and different sets of combinations of components that can satisfy the same functionality required in the new product [10,11]. In the conceptualization phase, three sets of combinations were made as listed in Table 3.

Pugh concept selection method as shown in Table 4, is a relative comparison technique which is created by the design team in order to decide what is the final design concept that match our criteria. In this method, one commonly found concept was chosen to become the datum, which is a reference concept to which all other concepts can compare with. Three level ordinal scale was used, which is better (+), worse (-) and same (S).

Through the comparison between the three conceptual designs that were proposed, the concept that had the most criteria satisfying the customer requirements was selected to become the prevailing concept of this project. The detail drawings for engineering use contains the key points to provide the manufacture or fabricator the description of each component while also defines and communicates part of a complete design to other stakeholders. It provides information on assembly and the junctions between components, showing the details of construction as outlined by Dieter and Schmidt in [10] and Ulrich and Eppinger in [11]. The self-reeling hose for bathroom use was drawn using the SolidWorks CAD software. Each component has its own functionality in order to make sure the product can be operated properly. The final combination and assembly drawing is shown in Figure 1. Meanwhile, Table 5 describes the main components.

Table 1 House of Quality (HOQ) for the Retractable Hose

Improvement Direction		↓	↓	↓	n/a	↑	n/a	n/a	↓	↑				
Units		kg	m	RM	-	N/m	-	-	%	-				
Customer Requirements, CR	Important Weight Factor	Engineering Characteristics, EC								Competitor Ranking				
		Weight	Size	Cost of material	Type of material	Tension of spring	Power Sources	Installation Position	Weather Resistance	Jamming Probability	A: Our Product	B: Competitor A	C: Competitor B	D: Product Rating
Weatherproof	3				3				9		3	5	3	3
Lifespan	5				9				9		5	5	3	5
Does not jam	5				3	3	1			9	3	3	5	5
Safety Features	5				3			1			5	5	3	5
Easy Installation	3	3	3					3			3	3	5	5
Production Cost	4			9	9		3				5	1	3	3
Cost of Maintenance	4				3		3				3	3	1	3
Portable	3	9	9								5	3	1	5
Space Needed	3		9					3			5	3	3	5
Efficiency	5				3	9			1	9	3	3	5	5
Raw Score (561)		36	63	36	147	60	29	23	77	90				
Relative Weight %		6.4	11.2	6.4	26.2	10.7	5.2	4.1	13.7	16.0				
Rank Order		6	4	6	1	5	8	9	3	2				

Table 2 Morphological Chart of the Self-Reeling Hose







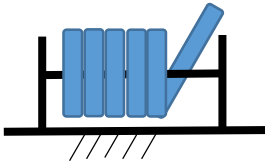
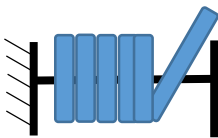
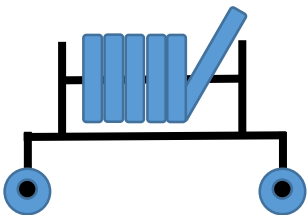

Function	Options		
Hose Reel	Stationary Hose Reels 	Wall-mounted Hose Reels 	Hose Reel Carts 
Design	Open Style 	Hideaway 	
Powered Sources	Spring Powered 	Water Powered 	Battery Powered 
Mechanism use to stop reeling	Gears 	Ratchet and Pawl 	
Hose	Rubber Hose 	Vinyl Hose 	Antimicrobial Hose 
Nozzle	Brass Adjustable Hose Nozzle 	Pistol Grip Nozzle 	

Table 3 Ideation or Conceptualization Phase

Function	Concept 1	Concept 2	Concept 3
Hose Reel	Wall-mounted Hose Reels	Stationary Hose Reels	Hose Reel Carts
Design	Open Style	Hideaway	Open Style
Powered Sources	Spring Powered	Water Powered	Battery Powered
Mechanism use to stop reeling	Ratchet and Pawl	Gear	Gear
Hose	Vinyl Hose	Rubber Hose	Antimicrobial Hose
Nozzle	Brass Adjustable Hose Nozzle	Pistol Grip Nozzle	Brass Adjustable Hose Nozzle

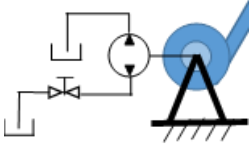
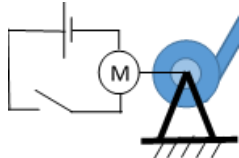
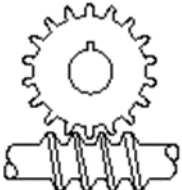
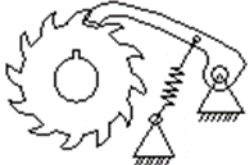
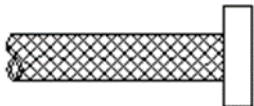
This retracting mechanism is a spring-loaded mechanism that enables the user to retract and rewind the hose automatically. Moreover, the spring powered hose retracting mechanisms are more durable than other types of hose reel, thus the price will also be competitive compared to others [1]. The most suitable hose length that is commonly used for gardens in front or back yards may cover 25 to 100 feet or 7.6 to 30 meters. These lengths can still be reeled back by spring actuated mechanisms. If the hose length exceeds 30 m, the spring load will be higher causing the hose to be harder to pull, hence requiring other types of power source for the retracting mechanism such as electrical, water, or air actuation [12].

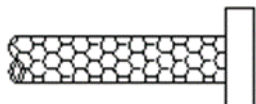
Table 4 Pugh Selection Method

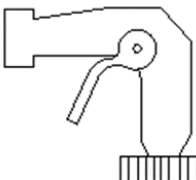
Selection Criteria	GARTENKRAFT Retractable Garden Hose Reel (Common)	Concepts		
		1	2	3
Weather Resistance	DATUM	-	-	-
Lifespan		-	-	-
Jamming Probability		S	+	S
Weight		+	-	-
Cost		+	+	+
Size		+	-	-
Portable		S	-	+
Space Needed		+	-	-
Effectiveness of mechanism		S	S	+
# of Pluses		4	2	3
# of Minuses	2	6	5	

In a related machine, Webster in [13] stated that the starter rewind spring mechanism has a starter housing or casing assembly that includes the starter rope, starter pulley (reel), and starter rewind spring. The pull rope is used to rewind starter pulley to control the rotational of body for starting. The starter rewind spring is reeled in a circle in which the starter housing is attached to the outer end of the starter pulley and it also connects to the inner end of rewind spring. When the user pulls the rope making the starter pulley to rotate, the spring will rewind in clockwise direction to compress the inside the starter housing. When the user lets go of the handle, the spring will rotate counterclockwise to rewind the rope in the opposite direction.

There are many categories of the material of the prototype that need thorough considerations in order to get the most suitable material for the fabrication process of the project prototype development. When selecting the hose, there are several factors to consider such as whether the hose will be subject to high or low pressures, the temperature of surrounding is hot or cold or even exposed to corrosive conditions [14]. According to these factors, the characteristics will assist in selecting the hose that best meets the needs of self-reeling hose for bathroom use.

The first type of hose is rubber hose. The rubber hose is the most durable hose that is generally the strongest and most long-lasting. Unlike a vinyl hose, rubber hoses are heavier and harder to handle and carry the highest price tag. However, they are better suited for extreme weather conditions and last through many seasons [15]. The benefit of rubber hose is being able to carry both hot and cold water; hot water can easily be transferred through a rubber hose. It is also more resistant to kinks and cracking. Rubber stands up to the toughest jobs and it is more durable since it is usually reinforced with nylon wire cord or polyester. On the other hand, rubber hoses can be easily damaged by ultraviolet (UV) rays. Hence, consumer need to try to store the rubber hose out of direct sunlight [16]. Needless to say, this is not a problem for bathroom use since bathrooms are most likely inside buildings.

The length of the hose needed depends on the area of the bathroom where the self-reeling hose is installed. As a reference, typical gardening hose can be purchased within 25 feet (7.6 m) increments, but longer lengths are available due to personal needs. The standard hose diameter in the market is 5/8" diameter, some consumers prefer to use 3/4" diameter hose because it can deliver more water. However, the hose for the bathroom use only needs to deliver relatively small amount of water, so the 5/8" diameter is a good option for normal usage. A bathroom bidet may just need a 1.2 – 2.4 m hose with 12.5 mm diameter [17].

A rewind spring that is normally used in a spring-powered hose reels is shown in Table 5. The starter rewind spring was installed by securing the inner end and outer end of spring to the starter housing when the user winds in clockwise direction the spring will compress inside. Besides that, when the pull is released, the spring will rewind in the opposite direction that returns to the original position due to the tension of the spring.

The design and the easy installation of the self-reeling hose for bathroom use is the important points that may motivate consumers to buy the product. The most common configurations of the self-reeling hose are wall-mounted design and hose reel box design. The design of wall-mounted is the most widespread use in the self-reeling hose products. This design become a well-liked choice among consumers since they can be fitted on a solid wall out of the way. The fixed on the wall installation will be the neater and more tidy option. The wall-mount design will be lighter than other choices because the wall can support the weight in long period of lifetime. Some other models can have handle carry that make them easy for transportation, portable to carry and a space saver. Hence, even though for bathroom use, the hose may not be as heavy as the long garden hose, being mounted on the wall is space saving and keeps the hose away from the rather dirty bathroom floors.

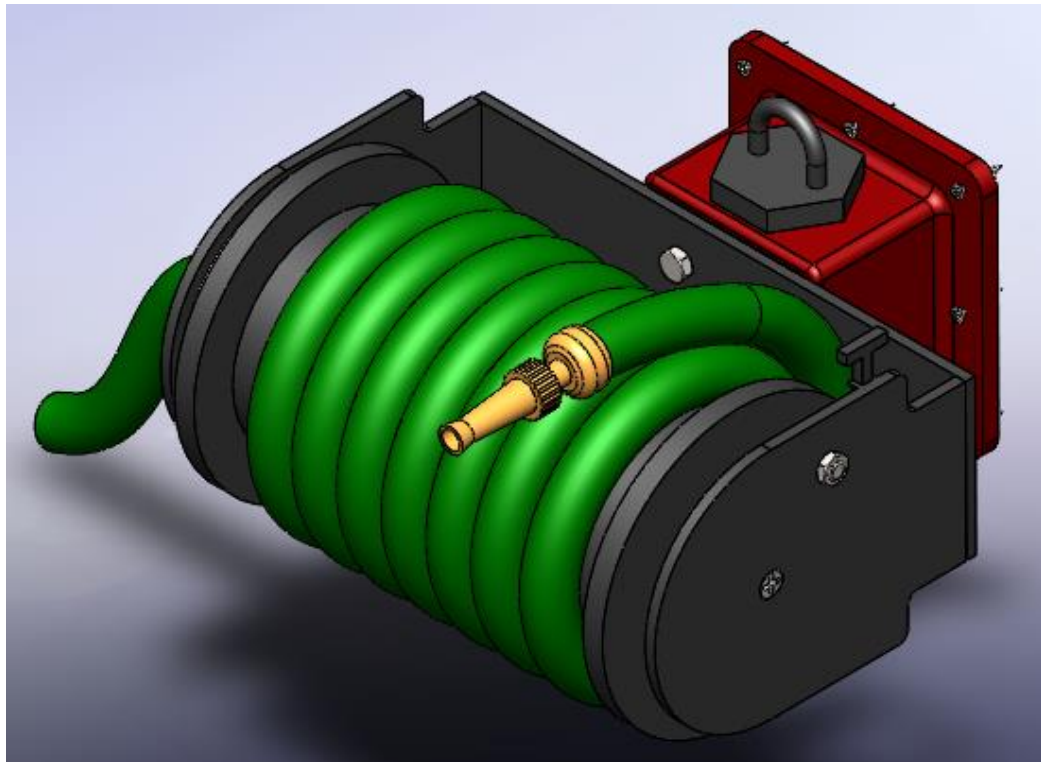
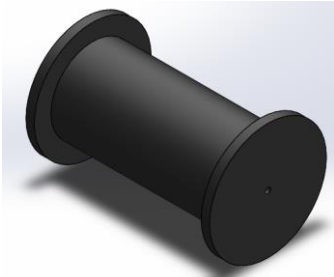
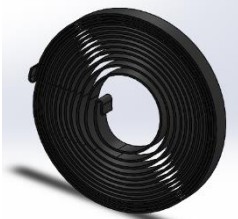
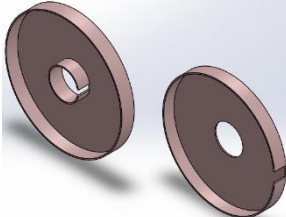
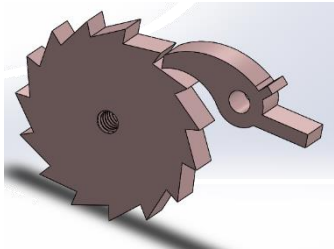
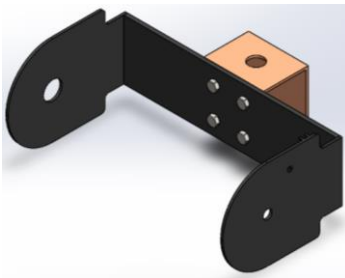
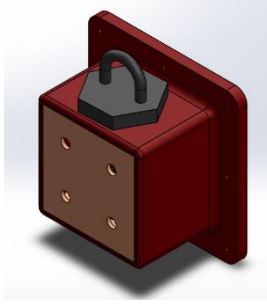
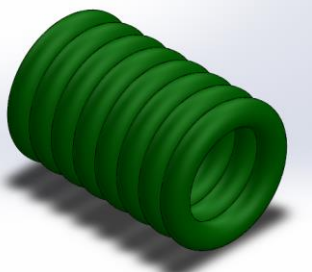
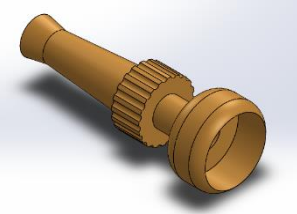

Figure 1. Assembly drawing of the hose.

Table 5 Component Description

Component	Detailed Design	Description
Main Body		The main body is located at the center of the device to provide the support of mechanism. It is designed small in size in order to suitably fit any size of the bathroom.
Starter Rewind Spring		The rewind spring was installed to store energy in clockwise rotation of the spring as it is compressed inside. When released, the spring will rotate counterclockwise to rewind the hose back in the opposite direction.
Spring Box		The case to secure the inner end and outer end of spring at the main body of the self-reeling hose.

Component	Detailed Design	Description
Ratchet and Pawl		<p>The ratchet and pawl system is used for locking the hose reel against retraction with the rewind spring. It is to allow only one shaft to rotate continuous linear in single direction while preventing movement in the opposite direction.</p>
Frame of Main Body		<p>The frame of main body is located at the center back of main body. It is used to secured and support the main body.</p>
Back Holder		<p>The back holder is used to mount the frame of main body on the wall.</p>
Hose		<p>The hose is used to carry the water in the bathroom.</p>
Adjustable Hose Nozzle		<p>The adjustable hose nozzle is attached to high pressure hose which can maintain the correct nozzle pressure. It can also be able to adjust spray patterns from pinpoint sharp to shower to achieve maximum reach with the water supply.</p>

A SolidWorks simulation is a virtual testing environment for analyzing the design, evaluating its performance and making decisions to improve the quality of the product. It provides an intuitive virtual testing environment for simulating linear static, time-based motion and fatigue simulation, which can be used with simple loads and supports to analyze a single body part or assembly as explained thoroughly by Erickson [18] and Stiehm [19]. SolidWorks simulation uses a numerical technique called the Finite Element Analysis (FEA) to predict the real-world physical behavior of a product through virtual testing of CAD models.

There are analyses of three parts in this work, which include the main body frame, starter rewind spring and the ratchet and pawl sub-assembly. The parts are chosen because they are the critical parts of the self-reeling hose mechanism where heavy loads are applied to them. In this paper, we

can calculate the factor of safety of the product and predict if it will cause premature failures to the designs, long before the actual fabrication is even done.

3. RESULTS AND DISCUSSION

The FEA was done to determine if the main body frame can support the load of the hose. The material selected for the main body frame is the AISI 1035 stainless steel. For the main body frame that is shown in Figure 2, the left and right side of round plate were fixed to prevent rotation of body in order to determine if it can withstand the hose weight at the middle of the body. The force of hose was applied at the top plane and all pointed downward. The force at the middle of the body which set as 50 N.

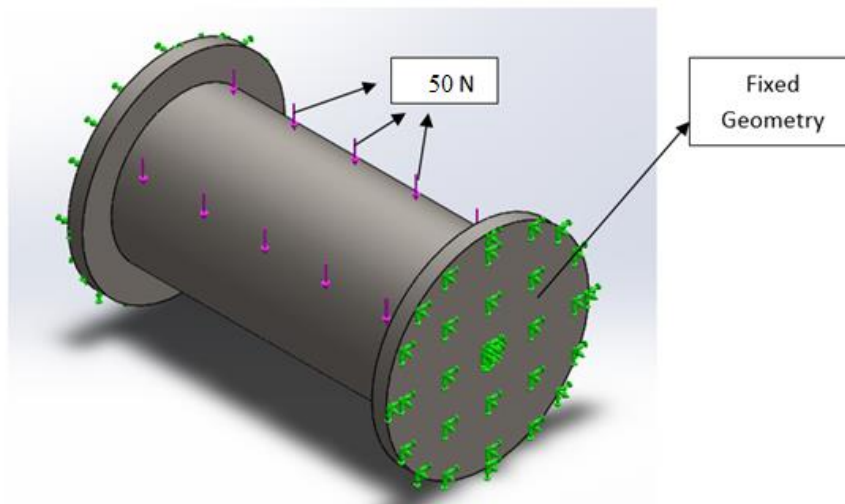

Figure 2. The assumption of location of fixed supports and force applied.

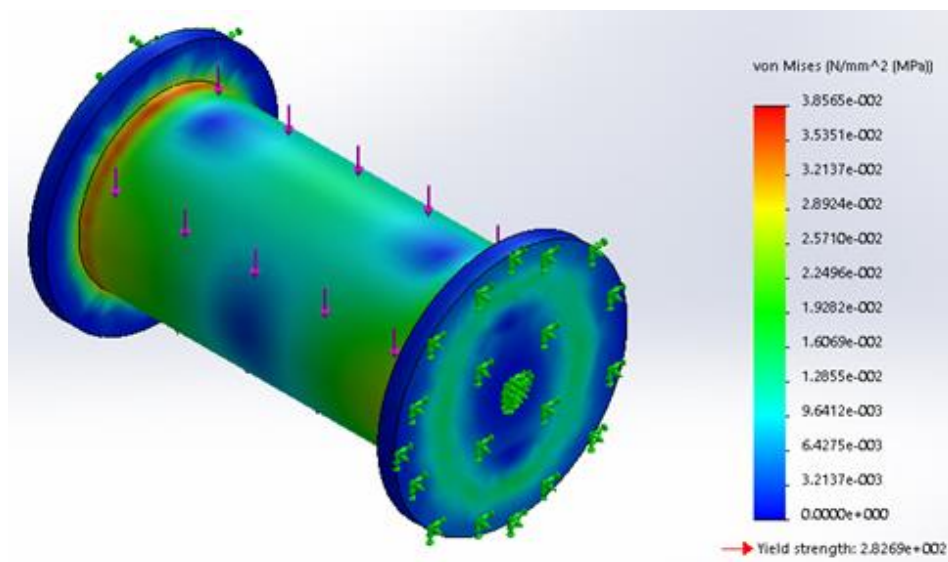

Figure 3. Result of von Mises stress distribution.

Based on Figure 3, the maximum stress resulted in the main body frame is 385 MPa. Hence, there is no risk of yielding since the yield strength of the AISI 1035 CD material is 460 MPa, which is greater than the maximum stress of the main roller body [20]. To remedy the high stress concentration, fillet needs to be added between the roller and the larger diameter end covers. Consequently, the maximum displacement of main body frame obtained is 0.00001825 mm that is shown by the red color region in Figure 4. This is practically negligible. From the analysis, it was found that the maximum strain of the main body frame is 1.518×10^{-7} mm/mm while the minimum strain is 2.67×10^{-10} mm/mm. Meanwhile, the minimum factor of safety is $460/385 \approx 1.19$ on this component of the system for the load given, which is safe enough for the system. This practically means, a lower strength material like AISI 1020 CD could be used instead. Hence, this could lower the cost of production as well.

The FEA was also done at the part of the starter rewind spring in order to determine if the starter rewind spring can withstand and retracts the hose back to the original position. The material assumption of starter rewind spring is cast carbon steel. For the starter rewind spring in Figure 5, the middle of spring was fixed to the spring box. The angular velocity of spring was set to 15 rad/s and applied at the center of the starter rewind spring with the clockwise direction due to the starter rewind spring was located at the left side of the main body frame. The maximum stress resulted in the starter rewind spring is 2.461 MPa. There is no risk of failing since the yield strength of the material is 248.2 MPa that is almost 100 times greater than the maximum stress in the starter rewind spring. The maximum displacement of starter rewind spring obtained is 1.069 mm that is shown in red color region in Figure 6. This outer end of the coil would turn with the roller.

Motion analysis of the ratchet and pawl mechanism was conducted by using SolidWorks software. The material assigned for the ratchet and pawl is also cast carbon steel. The linear spring was added to limit the pawl movement. Other than that, the faces of ratchet and pawl were initially touching so the simulate component contact was applied. The rotary motor was applied at the center of the ratchet with the counter-clockwise direction since the ratchet was located at the right side of the main body frame. When the tension retracts the hose release button, the ratchet is locked in the position of reel and that prevents it from retracting. The linear spring that is added with a spring constant k of 50 N/mm and its free length is approximately 10 mm. For simulation purpose, the speed of the motor was set around 55 rpm in the SolidWorks motion analysis. The ratchet and pawl shown in Figure 7 can be connected to a rotary motor and linear spring in motion analysis.

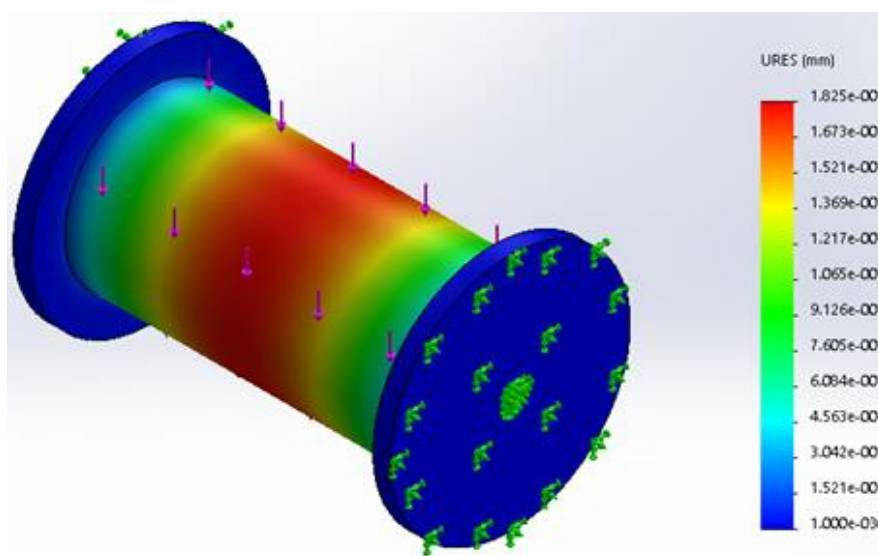

Figure 4. Result of distribution of displacement on the roller.

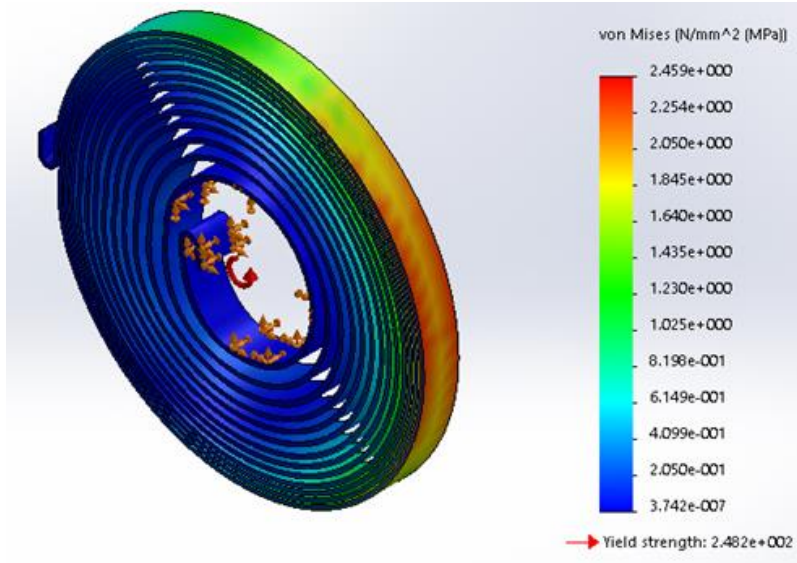

Figure 5. Result of the von Mises stress distribution on the spring.

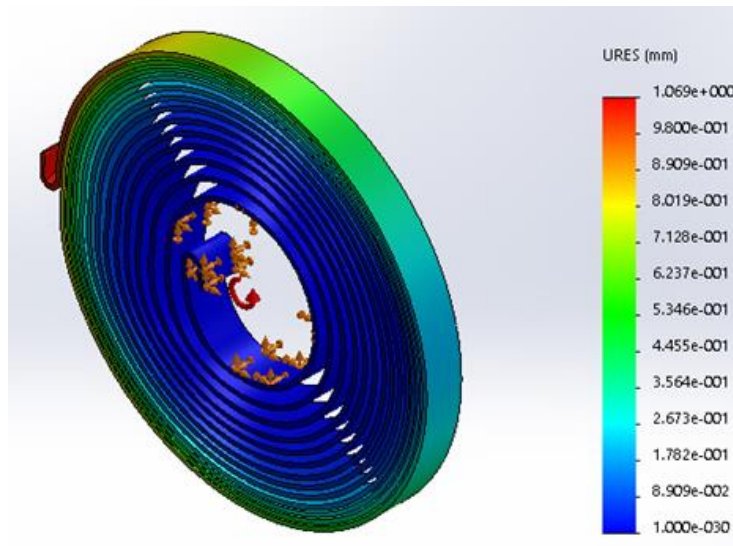

Figure 6. The displacement on the spring.

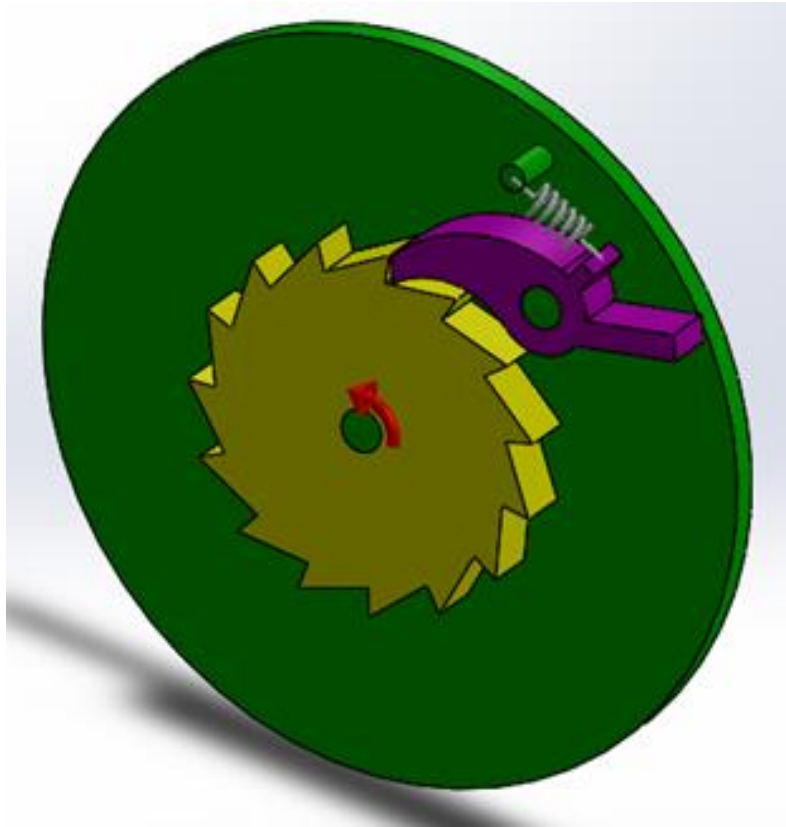

Figure 7. Ratchet and pawl with rotary motor and linear spring.

The bending strength of ratchets was calculated by using the theoretical formula of the ratchets to determine the safety of the ratchet mechanism in this system [21], which could also be related to the calculations suggested by KHK Gears in [22]. Additionally, general discussions on the topic of stresses in such machine components can be found in Budynas and Nisbett [20]. The working of the ratchet mechanisms is also briefly introduced by Sclater in [23] and Stern in [24].

For the ratchet, the bore hole (diameter) B is 10 mm, the outside diameter D is 70 mm, the number of teeth z is 15, its face width H is set to be 5.536 mm. The pitch angle ϕ is calculated as follows.

$$\phi = \frac{360}{z} = \frac{360}{15} = 15^\circ. \quad (1)$$

Next, the allowable transmission force at maximum bending force for the cast iron is determined as

$$F_b = \sigma_b \frac{Be^2}{6HS_F}, \quad (2)$$

where the web root length is

$$e = H \tan(60 - \phi). \quad (3)$$

Using $S_F = 2$ and $\sigma_b = \sigma_a = 225.55$ MPa at critical phase [21], the force F_b becomes 549 N. The allowable torque then can be calculated to yield

$$T = F_b r_f, \tag{4}$$

where the tooth root radius is

$$r_f = \frac{D - 2H}{2000} = \frac{70 - 2(5.536)}{2000} = 0.0295 \text{ m}. \tag{5}$$

Therefore, the torque T produced is 16.2 Nm. However, the amount of force needed to pull out the hose is so small and is not expected to get near the allowable limit. When it is time to rewind the hose, a release button is pushed, and the rewind spring would do its function. Figures 8 and 9 showcase the exploded view of the overall components in the system as well as the dimensions on the roller to give an idea of the overall size of the machine. For more extensive explanation and diagrams, check out the thesis by See [25].

4. CONCLUSION

The self-reeling hose is an innovation that delivers convenience in our lives, as it is used for hygienic purpose in the bathroom. Using the Pugh selection method, detailed design was carried out utilizing the power of computer aided engineering in SolidWorks. The drawings of the final conceptual design provided more specific information such as dimensions for each component. The stress simulation and calculation of the stress were performed, and all parts were rated with a factor of safety greater than unity, implying that the design is safe to use in normal circumstances.

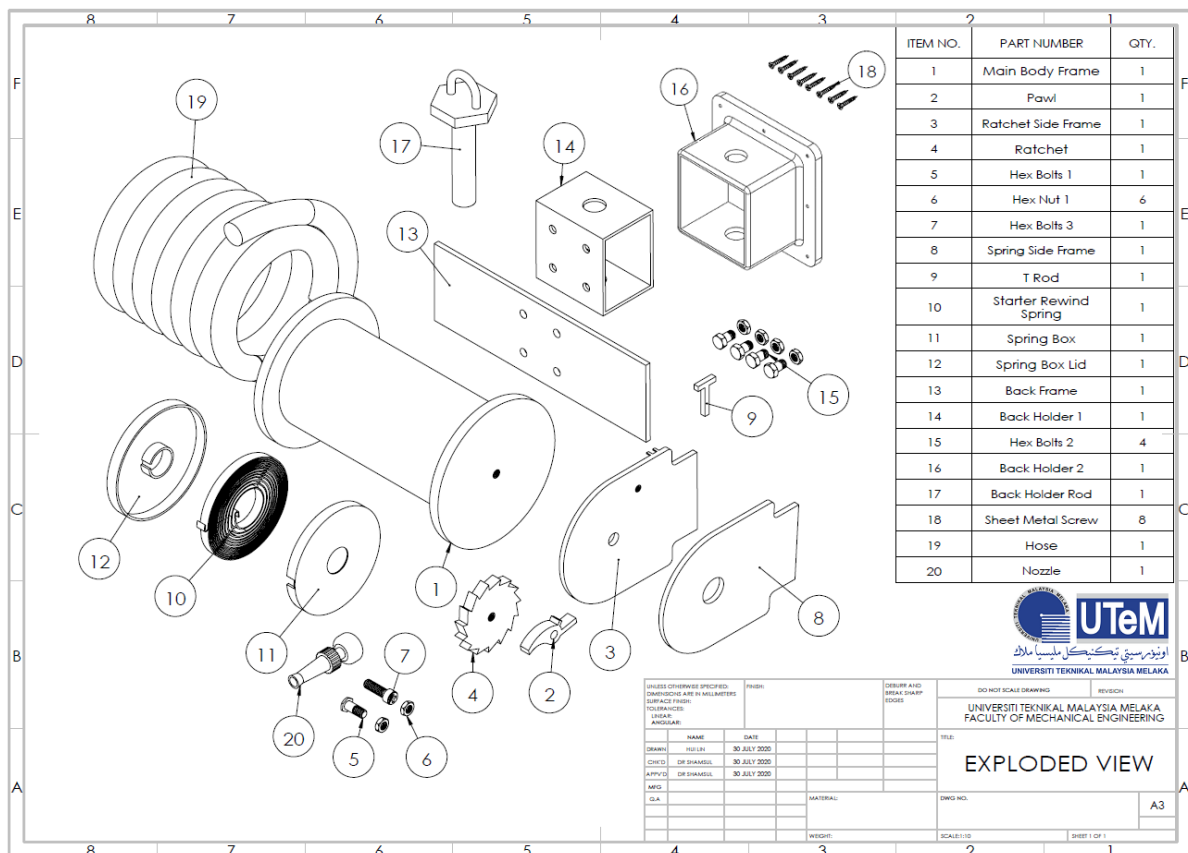

Figure 8. The exploded view of the invention.

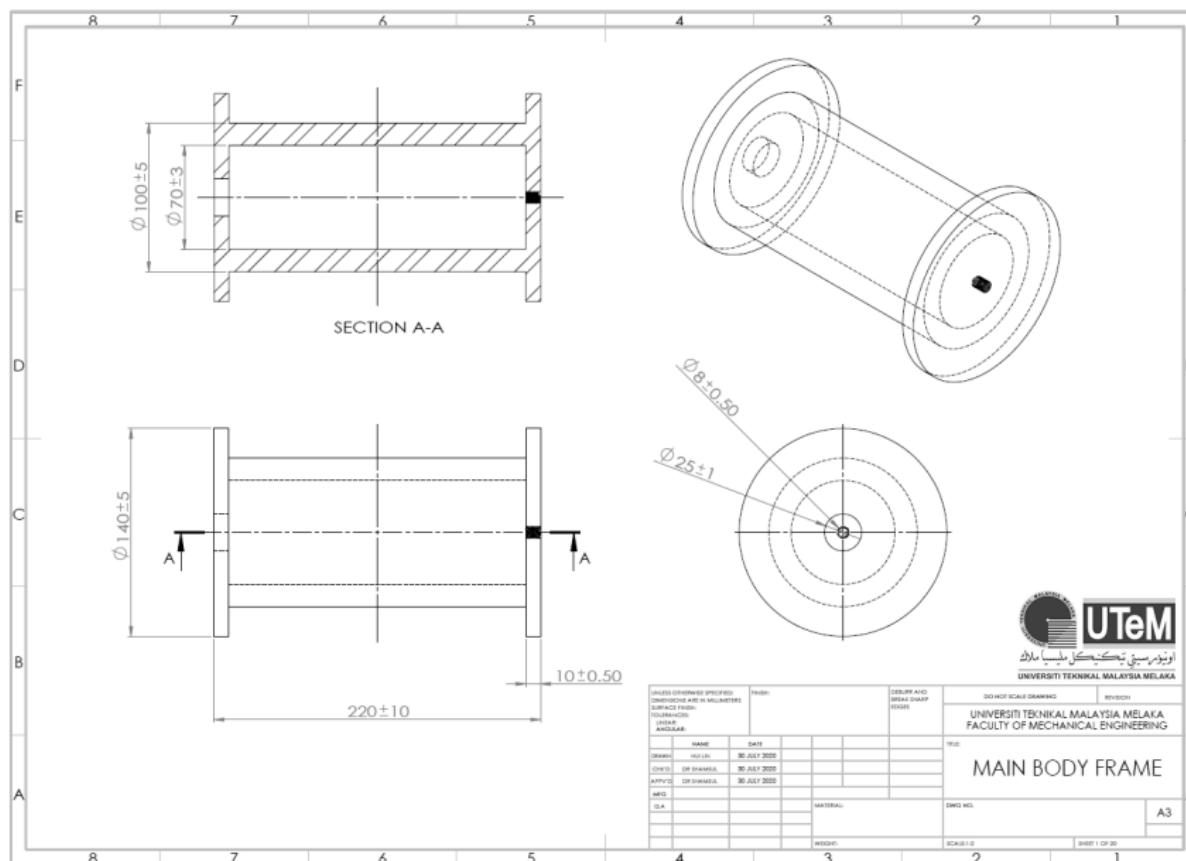

Figure 9. The dimensions in millimeters of the main body frame (roller) in multiple views.

ACKNOWLEDGEMENTS

The authors are grateful of the support and encouragement given by the Universiti Teknikal Malaysia Melaka (UTeM) and the Al Balqa Applied University (BAU) in completing and publishing this work.

REFERENCES

- [1] Miller, J., "Best Self Winding Hose Reel," Jen Reviews, 11 February, (2018). <https://www.jenreviews.com/best-self-winding-hose-reel>
- [2] Ericson, S., " Best Retractable Garden Hose Reel: Top 5 Self Winding Option To Buy In 2022," (2022). <https://www.urbanorganicyield.com/retractable-garden-hose-reel/>.
- [3] Chand, R., Sharma, V. S., Trehan, R., International Journal of Mechatronics and Manufacturing Systems, vol **14**, issue 2, (2021) pp. 164-179.
- [4] Arshad, A. B., Nazir, A., Jeng, J. Y., Int. J. Adv. Manuf. Technol. vol **118**, (2022) pp. 195–206. <https://doi.org/10.1007/s00170-021-07756-2>
- [5] Ali, M., Nazir, A., Jeng, J. Y., Int. J. Adv. Manuf. Technol. vol **111**, (2020) pp. 3273–3292. <https://doi.org/10.1007/s00170-020-06227-4>
- [6] Yuan, C., Wang, F., Qi, B., Ding, Z., Rosen, D. W., Ge, Q., Materials & Design, vol **193** (2020) 108785. <https://doi.org/10.1016/j.matdes.2020.108785>.
- [7] Das, A., Kumar, A., IOSR Journal of Mechanical and Civil Engineering, vol **12**, issue 55, (2015) pp. 82-91.

- [8] Zhang, Y., Mao, K., Leigh, S., Shah, A., Chao, Z., Ma, G., *Int. J. of Adv. Manuf. Tech.* vol **107**, (2020) pp. 4481–4492. <https://doi.org/10.1007/s00170-020-05270-5>
- [9] Pisula, J., Budzik, G., Turek, P., Cieplak, M., *Polymers*, vol **13**, 1649 (2021) pp. 1-20. <https://doi.org/10.3390/polym13101649>
- [10] Dieter, G. E., Schmidt, L. C., *Engineering Design*, 5th ed., New York: McGraw-Hill, (2013).
- [11] Ulrich, K. T., Eppinger, S. D., *Product Design and Development*, 5th ed., New York: McGraw-Hill, (2011).
- [12] Rodriguez, A., "The Difference Between 5/8-Inch and 3/4-Inch Garden Hose," 10 December (2018). <https://homeguides.sfgate.com/difference-between-5-8inch-3-4inch-garden-hose-47010.html>.
- [13] Webster, J., *Repairing your outdoor power equipment*, Albany, NY: Delmar, (2001).
- [14] Whitford, F., *The selection and inspection of hoses: An integral component of everyday equipment*, West Lafayette, IN: Purdue Extension, (2010).
- [15] Moran, M., "How to Choose the Right Garden Hose," 21 August (2020). <https://www.wikihow.com/Choose-the-Right-Garden-Hose>.
- [16] Maier, C., "Polyurethane Garden Hose vs. Rubber," 29 March (2019). <https://homeguides.sfgate.com/polyurethane-garden-hose-vs-rubber-84331.html>.
- [17] Fletcher, V., "11 Best Hand Held Bidet Sprayers of 2021," 13 January (2021). <https://yuzumag.com/roundup/best-hand-held-bidet-sprayers/>.
- [18] Erickson, A., "Introduction to SolidWorks Simulation Webinar: What is Finite Element Analysis?," 11 January (2019). <https://www.cati.com/blog/2019/01/introduction-solidworks-simulation-webinar-finite-element-analysis/>.
- [19] Stiehm, S., "SOLIDWORKS Simulation in a Multi-CAD Environment," 23 April (2020). <https://blog.alignex.com/author/sean-stiehm>.
- [20] Budynas, R. G., Nisbett, J. K., *Shigley's Mechanical Engineering Design*, 10th ed., New York: McGraw-Hill, (2014).
- [21] Padhal, D. K., Awachat, P. N., Deogade, A. Y., *IOSR Journal of Mechanical and Civil Engineering*, vol **11**, issue 4, (2014) pp. 27-34.
- [22] KHK, "Other Products," KHK, (2021). <https://www.khkgears.us/media/1240/3015-other-products.pdf>. [Accessed 3 August 2021].
- [23] Sclater, N., *Mechanisms and Mechanical Devices Sourcebook*, 5th ed., New York: McGraw-Hill, (2011).
- [24] Stern, M. L., "Novel mechanical mechanisms for the development of undergraduate knowledge," Undergraduate thesis, Department of Mechanical Engineering, Massachusetts Institute of Technology, Cambridge, MA, (2009).
- [25] See, H. L., "Development of a self-reeling hose for bathroom use," Undergraduate thesis, Faculty of Mechanical Engineering, Universiti Teknikal Malaysia Melaka, Melaka, Malaysia, (2020).